

CROSS-R / CROSS-RD

design Luigi Brebilla

Un gioco di soli rettangoli che si sovrappongono a formare un corpo scaldante deciso-

mente molto particolare. Può essere uno scaldasalviette ma può

essere anche un calorifero dalla pura forma decorativa per qualsiasi ambiente.

DIMENSIONI

Larghezze 60/68/80/104/144 cm

Altezze 71/137/177 cm

Profondità 6 cm

Sporgenza dal muro 10 cm

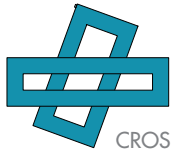

CROSS-R 70-80/ 70-104

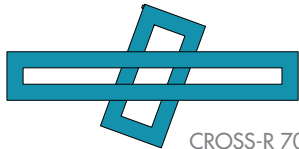

CROSS-R 70-144

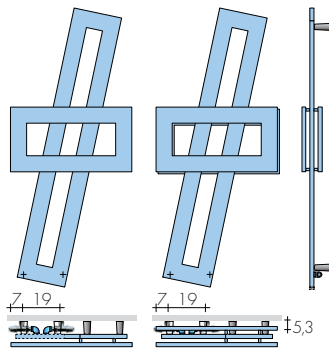

CROSS-R

CROSS-RD

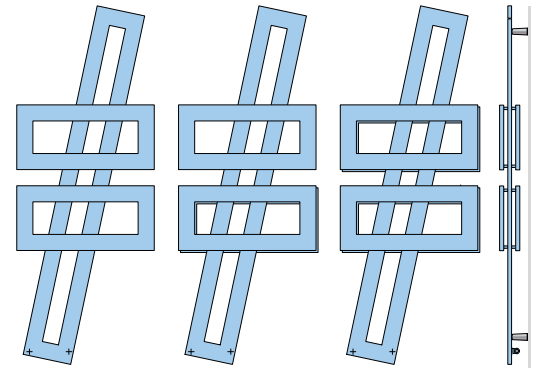

CROSS-2R

CROSS-3R

CROSS-4R

MODELLO	Watt Δt 50 K	▲ ▼ inf.att. cm	Altezza cm	Larghezza cm	Peso M Kg	Volume V dm ³	Resistenza elettrica classe I W	EN 442 Watt Δt 50 K
"SOLO QUADRI SOVRAPPOSTI"								
CROSS-R 70-80	379	66	71	80	7,3	4,4	400	
CROSS-R 70-104	433	90	71	104	8,3	5,0	400	
CROSS-RD 70-104	610	90	71	104	11,8	7,1	650	
CROSS-R 70-144	523	130	71	144	10,0	6,1	-	
CROSS-RD 70-144	700	130	71	144	13,5	8,2	650	
CROSS-R 137-60	484	19	137	60	9,5	5,8	-	
CROSS-RD 137-60	635	19	137	60	12,8	7,7	650	
CROSS-4R 137-60	901	19	137	60	19,4	11,7	900	
CROSS-R 177-68	590	19	177	68	11,6	7,0	650	
CROSS-RD 177-68	755	19	177	68	15,2	9,2	-	
CROSS-2R 177-68	760	19	177	68	15,2	9,2	-	
CROSS-3R 177-68	898	19	177	68	18,8	11,4	900	
CROSS-4R 177-68	1046	19	177	68	22,5	13,6	-	
R-CROM 70-104	364	90	71	104	8,3	5,0	400	
R-CROM 70-144	439	130	71	144	10,0	6,1	400	
R-CROM 137-60	387	19	137	60	9,5	5,8	400	
R-CROM 177-68	472	19	177	68	11,6	7,0	-	
RD-CROM 177-68	605	19	177	68	15,2	9,2	650	

• Valvole Reverse Brem: si consiglia modello Quadra

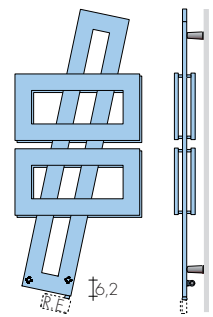
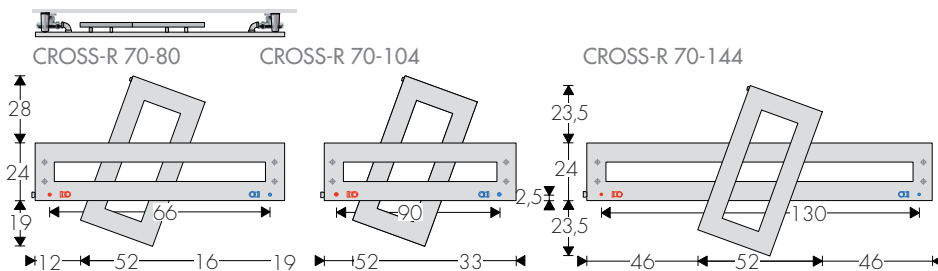

ESECUZIONI DI SERIE

Colore bianco sablé SB9010, mensole bianche
Finitura cromata con mensole cromate

ESECUZIONI A RICHIESTA

Verniciatura in una tinta della tabella colori
Brem con mensole cromate +15/35%

ATTACCHI DI SERIE

REG Ø 1/2" valvole reverse
Versione elettrica e mista,

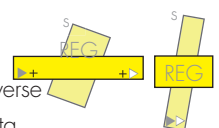

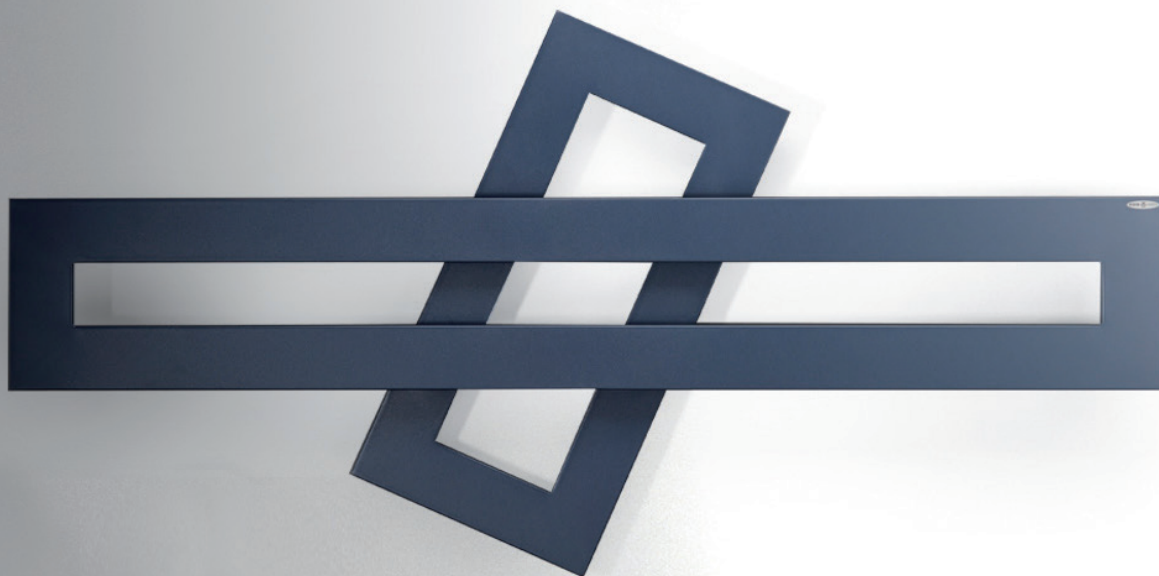

DIMENSIONI

Larghezze 48/56/64 cm
 Altezze 104/144/184 cm
 Profondità 6 cm
 Sporgenza dal muro 10 cm

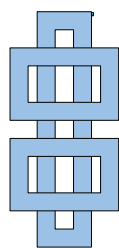

CROSS-R 104-..

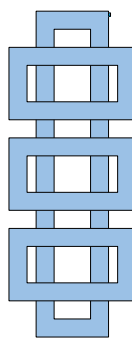

CROSS-R 144-..

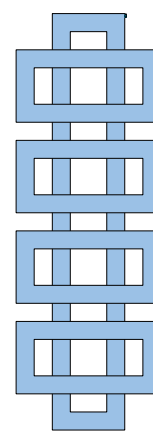

CROSS-R 184-..

EN 442 Watt Δt 50 K

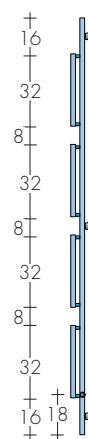

MODELLO		Watt Δt 50 K	▲ ▼ int.att. •cm	Altezza H (H ₁) cm	Larghezza L (L ₁) cm	Peso M Kg	Volume V dm ³	Resistenza elettrica classe I W
"SOLO QUADRI SOVRAPPOSTI"								
CROSS-R	104-48	505	36	104 (72)	48 (24)	10,4	6,3	400
CROSS-R	104-56	555	44	104 (72)	56 (32)	11,4	6,9	400
CROSS-R	104-64	589	44	104 (72)	64 (32)	12,1	7,3	650
CROSS-R	144-48	692	36	144 (112)	48 (24)	14,5	8,8	650
CROSS-R	144-56	758	44	144 (112)	56 (32)	15,9	9,6	650
CROSS-R	144-64	808	44	144 (112)	64 (32)	16,9	10,3	900
CROSS-R	184-48	901	36	184 (152)	48 (24)	19,4	11,7	900
CROSS-R	184-56	982	44	184 (152)	56 (32)	21,1	12,8	900
CROSS-R	84-64	1046	44	184 (152)	64 (32)	22,5	13,6	-

PRESSIONE MASSIMA DI ESERCIZIO 3 BAR ATTACCHI per VALVOLE REMOTE pag.240

ESECUZIONI DI SERIE

Colore bianco sablé SB9010, mensole bianche

ESECUZIONI A RICHIESTA

Verniciatura colori Brem

+15/35%

ATTACCHI DI SERIE

CD ø 1/2" sul rettangolo posteriore

