

HERG-ÖT

design Luigi Brembilla

Herg-ÖT recalls the iconic shape of the ladder and can be placed perpendicular

or slightly inclined. The parallel tubes give comfort and warmth to the bathroom and

work as a support for clothing, bathrobes and towels.

DIMENSIONS

Width: 42 / 50 / 58 cm
Height: 184,7 / 212,4 / 240 cm
Depth: 12 cm
Depth from wall: 12 cm

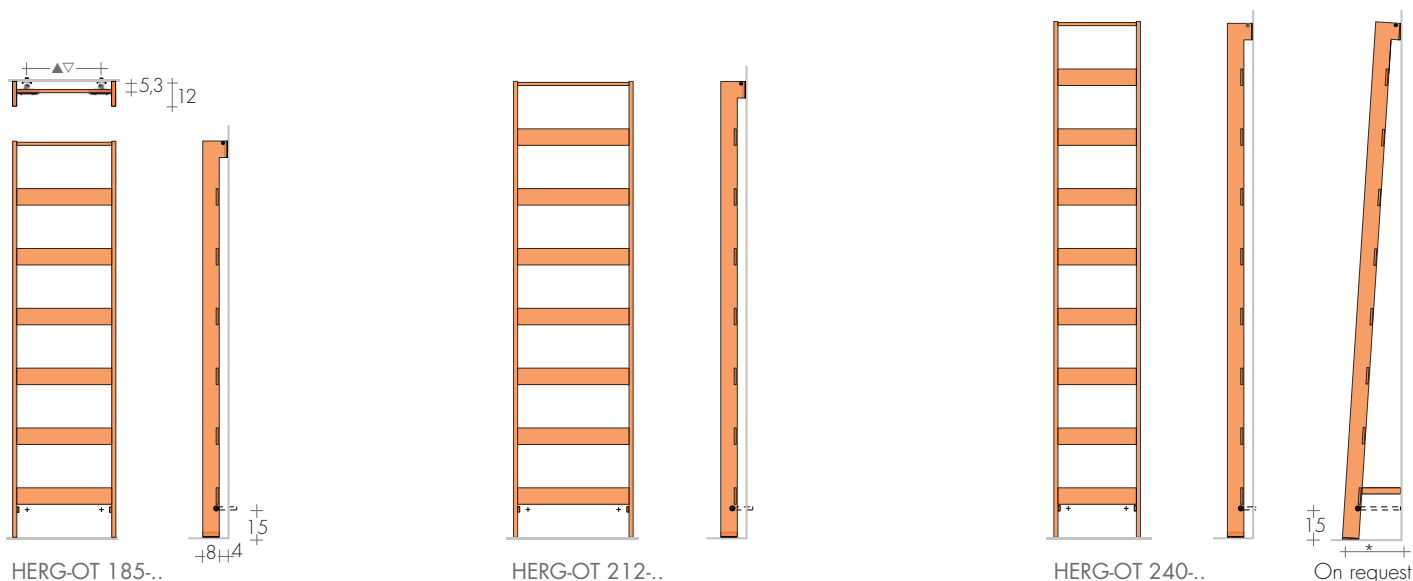

MODEL'21

	H/L cm
HERG-ÖT	185-42
HERG-ÖT	185-50
HERG-ÖT	185-58
HERG-ÖT	212-42
HERG-ÖT	212-50
HERG-ÖT	212-58
HERG-ÖT	240-42
HERG-ÖT	240-50
HERG-ÖT	240-58
On request, ANGLED HERG-ÖT	
Art. HOI	

EN 442		▲ ▼	Height	Width	Weight	Volume
Δt 50 K	Δt 30 K	t.c.	H (H _i)	L	M	V
watt	watt	cm	cm	cm	Kg	dm ³
625	329	27	184	42	11,5	6,0
669	352	35	184	50	12,3	6,3
713	375	43	184	58	13,0	6,5
735	387	27	216	42	13,5	7,1
787	414	35	216	50	14,4	7,3
840	442	43	216	58	15,3	7,6
845	444	27	248	42	15,6	8,1
906	476	35	248	50	16,6	8,4
966	508	43	248	58	17,6	8,7

Δt 40K = W Δt 50K x 0,755

Ready Stock

STANDARD PRODUCTION

White "sablé" paintwork SB9016
Tolerance ± 3mm - Air vent ø 1/8"
MAXIMUM OPERATING PRESSURE 4 BAR

PRODUCTION ON REQUEST

Paintwork to Brem color list
(with colored brackets)
Electric version e.Herg-öt, p.239

+15/25%

STANDARD FITTING

REG ø 1/2"
On request fittings ø 3/8"
Special fittings, page 287



TAPPING CENTRES

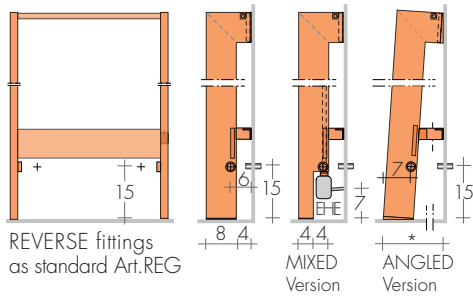

*On request:
ANGLED HERG-ÖT
Art. HOI

Herg-öt 185:*24 cm
Herg-öt 212:*26 cm
Herg-öt 240:*28 cm

REMOTE FITTINGS

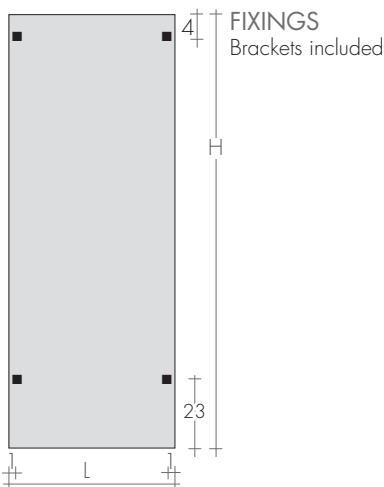
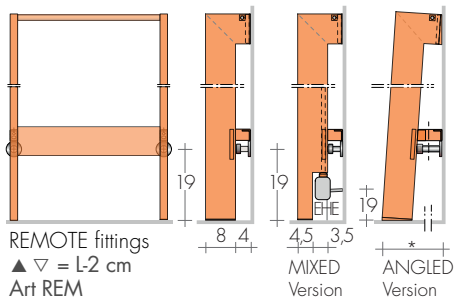

RECOMMENDED VALVES

CHROME PLATED VALVES KIT WITH:
- n°2 Valves with O-ring Tangs
- n°2 Fittings (multilayer ø16, copper ø12,14)
- n°2 Round washers
On request: Polished stainless tube cover
(to be cut to right size) Art. CA18

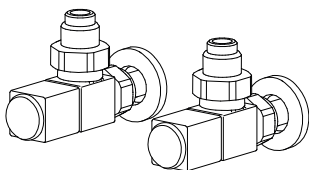

ANGLED QUADRA VALVES KIT
page 279 Art. KQS
extra for BREM color list

ANGLED MINI VALVES KIT
chrome-plated or white color Art. KMS

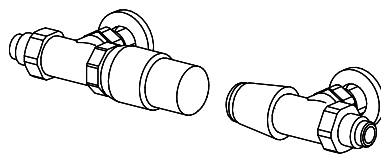

REVERSE TON VALVES KIT with
THERMOSTATIC head Art. KTR

REVERSE TON VALVES KIT
page 277 Art. KVR

REMOTE FITTINGS Art. REM
Remote fittings at the rear: ▲ ▽ L-2cm

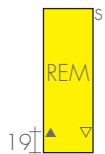
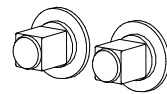

REMOTE VALVES ASSEMBLY KIT p.281 with:
- n°2 Fittings (multilayer ø16, copper ø12,14)

REMOTE QUADRA VALVES ASSEMBLY KIT
Art. KQG

REMOTE TON VALVES ASSEMBLY KIT with
THERMOSTATIC head Art. KVGT



HERG-ÖT 212-42