

FLAG

PRICE FROM 1.07.2022 **+15%**

design Luigi Brembilla

Built with a sober and smooth new radiating plate, FLAG also features a special

towel warmer with rails in the shape of the flags that distinguish its design.

The towel rail can be personalized with exclusive finishes in the Brem color range.

DIMENSIONS

Length: 53,5 cm
 Heights: 88 / 95 / 124 / 145 / 167 cm
 Depth: 10,5 cm
 Depth from wall: 14 cm

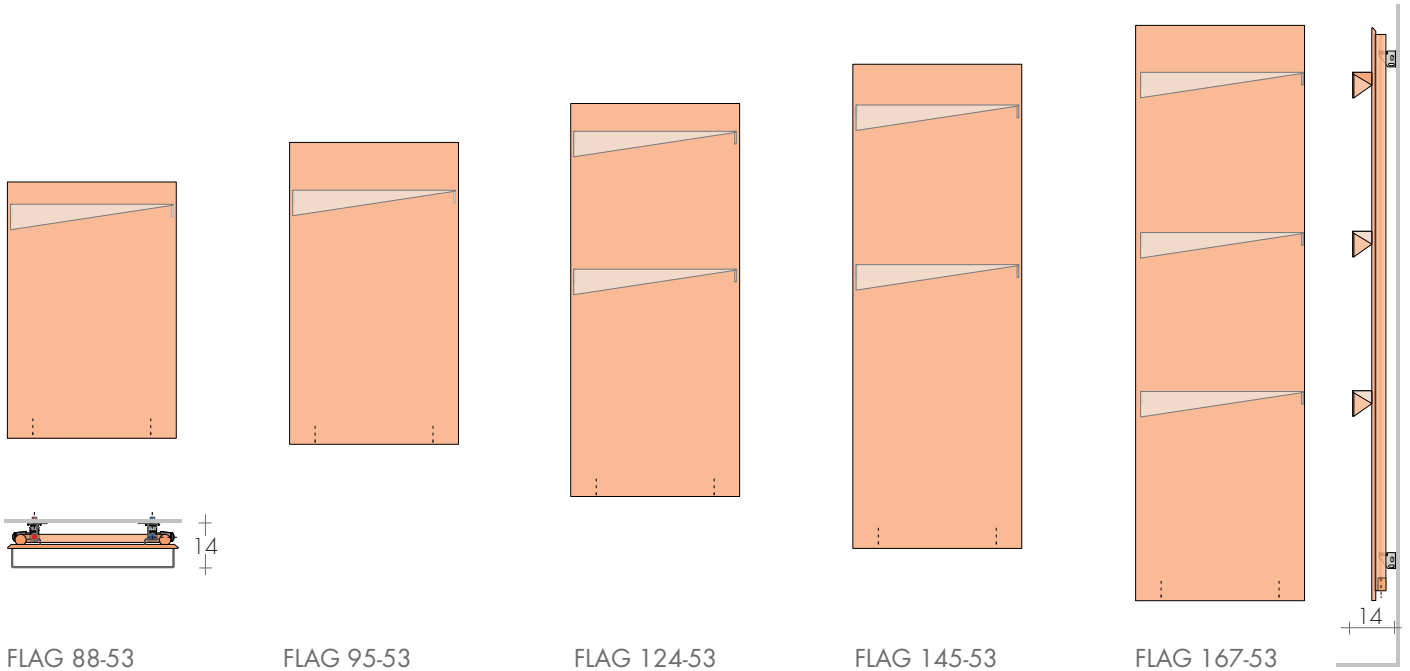

FLAG 88-53

FLAG 95-53

FLAG 124-53

FLAG 145-53

FLAG 167-53

MODEL

MODEL	HL cm	white sablé standard €	EN 442		▲ ▽ t.c. cm	Height H cm	Width L cm	Weight M Kg	Volume V dm³	MIXED version* (EHE cl.II):	
			Δt 50 K watt	Δt 30 K watt						cable ^o €	digital thermostat W €
FLAG	88-53		408	210	37	88	53,5	11,9	4,2		400
FLAG	95-53		490	252	37	95	53,5	13	4,6		500
FLAG	124-53		653	336	37	123,5	53,5	17,3	6,1		650
FLAG	145-53		775	398	37	145	53,5	20,6	7,3		800
FLAG	167-53		897	461	37	166,5	53,5	23,8	8,4		900

Δt 40K = W Δt 50K x 0,755

Radio frequency chronothermostat p.227

TOWEL BAR FLAG: STANDARD COLORS

- white sablé SB 9016
- quartz grey SB 7039
- jet black SB 9005
- same color ordered with the radiator

In one paintwork to Brem color list different from the radiator extra



MIXED VERSION*
 with valves in sight
 height = H-7cm
 t.c. = ▲ ▽ 5 cm

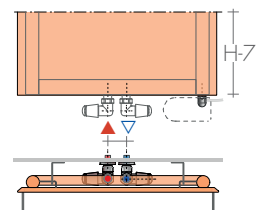

STANDARD PRODUCTION

White "sablé" paintwork - white EOS brackets
 Tolerance ± 3mm - Air vent ø 1/2"
 MAXIMUM OPERATING PRESSURE 6 BAR

PRODUCTION ON REQUEST

Paintwork to Brem list with colored brackets
 (white back side and manifolds) +15/25%
 Back and manifolds same color as radiator 132€

STANDARD FITTING

EG ø 1/2"
 BREM valves, page 273
 Electric version e.Flag, page 255



TAPPING CENTRES

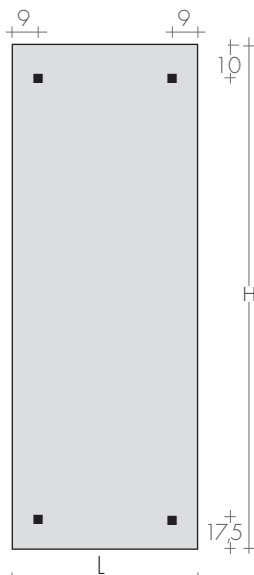
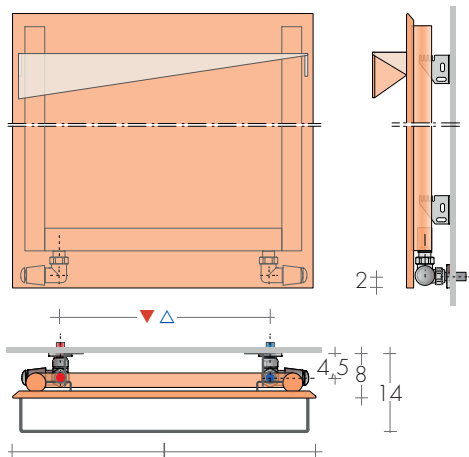

FIXINGS
Brackets included



EOS bracket



FLAG 145-53

RECOMMENDED VALVES

as standard at the rear of the radiator

CHROME PLATED VALVES KIT WITH:

- n°2 Valves with O-ring Tangs
- n°2 Fittings (multilayer ø16, copper ø12,14)
- n°2 Round washers

On request: Polished stainless tube cover
(to be cut to right size) Art. CA18 10,80€

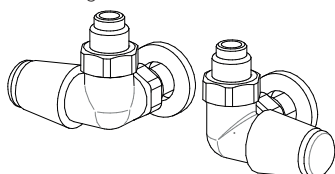

SIDE CONTROL TON VALVES KIT nickel-plated
chrome-plated handwheel Art. KVLN 91,80€

SIDE CONTROL TON VALVES KIT chrome-plated
page 277 Art. KVL 130,90€

SIDE CONTROL QUADRA VALVES page 279
chrome-plated Art. KQL 166,30€
extra for BREM color list 46,40€

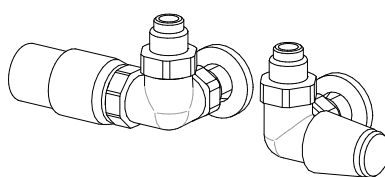

SIDE CONTROL TON VALVES KIT nickel-plated
with THERMOSTATIC head Art. KTLDN 135,00€

SIDE CONTROL TON VALVES KIT chrome-plated
with THERMOSTATIC head Art. KTLD 177,10€

REMOTE FITTINGS Art. REM 36,60€
tapping centres (Panel H - 7cm): ▲▼ L-8,5cm

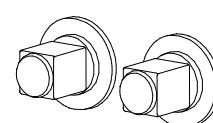

2,5€



REMOTE VALVES ASSEMBLY KIT p. 281 with:
- n°2 Fittings (multilayer ø16, copper ø12,14)

REMOTE QUADRA VALVES ASSEMBLY KIT
Art. KQG 167,70€

REMOTE TON VALVES ASSEMBLY KIT with
THERMOSTATIC head Art. KVGT 199,80€